

Article number: 07112051001

Description: Universal joint single 0.112.051.001
S=125 X= Bore with keyway

Measures

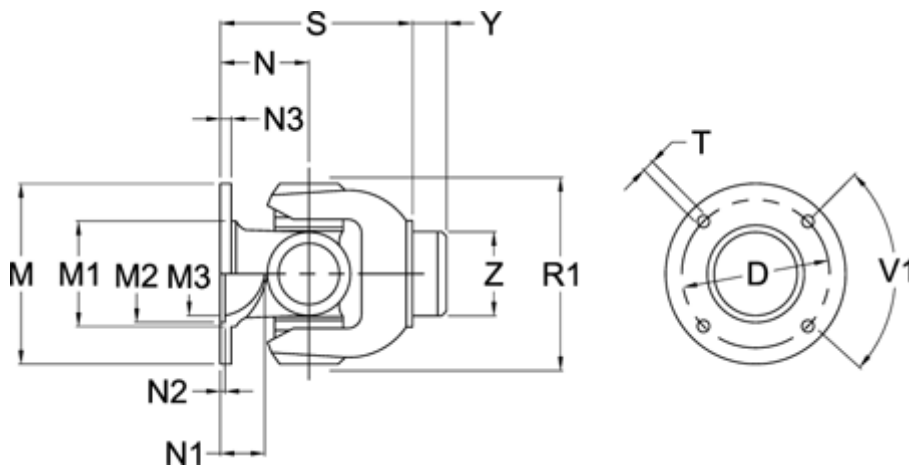

D	= 130 +0,1	N2	= 3 +0,5	Z = 52.25
Flange diameter M	= 150	N3	= 9	
M1	= 101	Number og Flangeholes	= 8	
M2	= 90	R1	= 115	
M3	= 78	S min	= 125	
Max. Bending Angle degrees	= 18	T	= 10 B12	
N	= 60	V1 degrees	= 45	
N1	= 33	Y	= 20	